

CENTRALE DE CONTROLE MOD. C 109/1

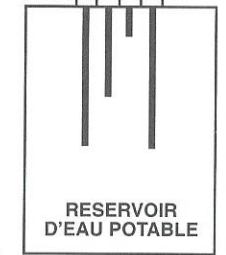
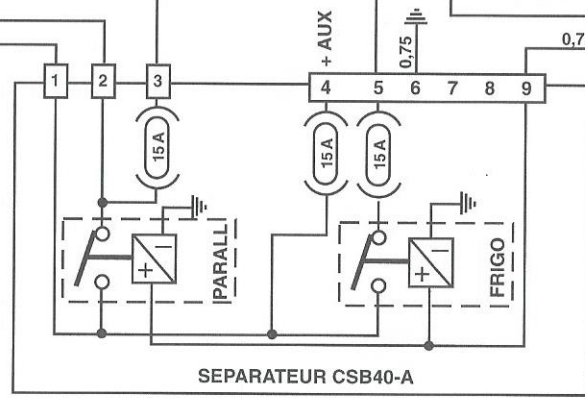
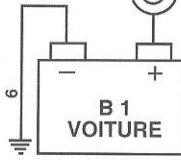
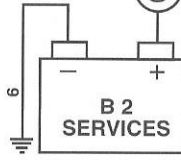
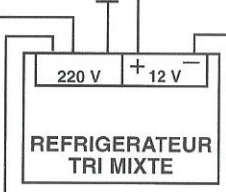
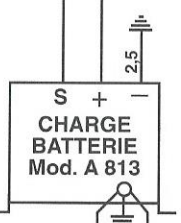
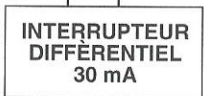
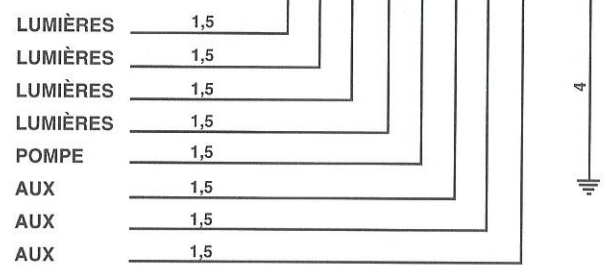
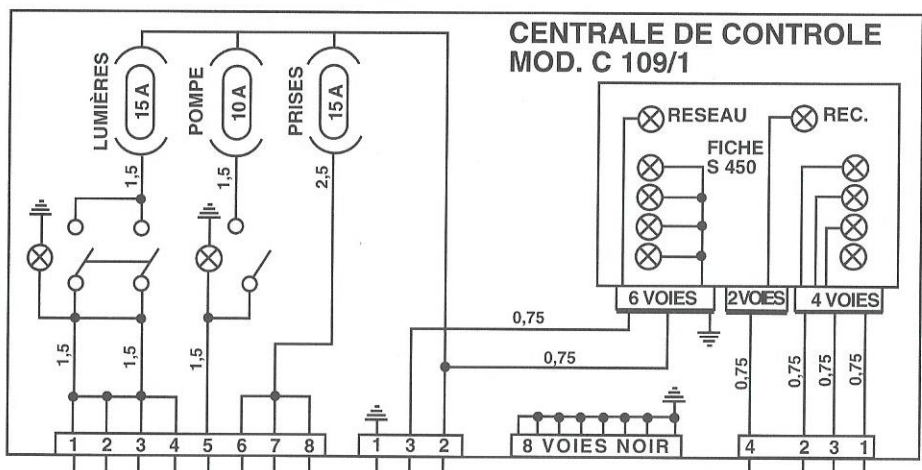

+ GENERATEUR MOTEUR